

Invacare IBERIA

Tel. (34) 900 992 841

E-Mail: contactsp@invacare.com

www.invacare.es

Küschall
UNLIMIT YOUR WORLD



Yes, you can.®

KÜSCHALL COMPACT



Silla manual activa de chasis plegable por cruceta de aluminio hidroformado.

Opciones de pescantes extraíbles y abatibles int/ exterior o pescantes fijos.

Respaldo ajustable en ángulo y abatible sobre el asiento disponible como opción.

Doble cruceta a partir de ancho 44 cm.

Gran número de tallas y opciones.

Protectores de ropa antisalpicaduras fijos de composite. Opción de reposabrazos.

Peso máximo usuario : 130kg.

Peso : a partir de 9,6 kg* (pescantes fijos).

Peso de transporte: a partir de 6,7 kg* (pescantes fijos).

Packs de Posicionamiento & Prevención de úlceras disponibles!

Descubra las posibilidades de personalización gracias a la fabricación especial **UNIQUE** que permite crear modelos UNICOS! Configure su silla con el nuevo configurador visual: www.kuschall.com
Nos reservamos el derecho a una tolerancia de + - 1 cm en las medidas.
Nos reservamos el derecho a introducir cambios técnicos sin previo aviso!
Nota: producto configurado a medida i No se admiten devoluciones!
Compact SR-40F: Código provisional Prescripción (comunicado): S0008985 (Categoría SRM 040F)

Ortopedia :

Nombre usuario :

Dirección usuario :

Teléfono contacto :

Dirección entrega:

Número pedido :

Cantidad pedido :

Fecha pedido :

Por favor marque su elección con una cruz : Característica estándar Sin cargo

Peso usuario = Kg

Código	Descripción	P.V.P €
MODELO		
DCA0012	KÜSCHALL COMPACT 2.0	2.619,75
UNIQUE FABRICACIÓN ESPECIAL O PERSONALIZACIÓN		PLAZO DE ENTREGA ADICIONAL: + 20 DÍAS
DCA0000	UNIQUE FABRICACIÓN ESPECIAL : BAJO PRESUPUESTO (contactar con el departamento de Atención al Cliente)	
UCA0001	UNIQUE - PERSONALIZACIÓN	VER TODAS LAS OPCIONES UCAXXXX
PACK POSICIONAMIENTO		
DCA0220	PACK 1- POSICIONAMIENTO & PREVENCIÓN DE ÚLCERAS LIBRA/MX2 NUEVO	INCLUYE : COJÍN MATRX LIBRA (DCA2720) RESPALDO MATRX MX2 (DCA2300 a DCA2315) CINTURÓN POSTURAL BODYPOINT EVOFLEX (DCA7810 a DCA7830) Anchura 360 mm solo posible con Profundidad 400/420 mm (NC : 1300, 1305, 1310, 1315, 1350, 1355, 1400, 1405, 1415, 1425, 2200, 2210, 2220, 2230, 7230)
DCA0230	PACK 2 - POSICIONAMIENTO & PREVENCIÓN DE ÚLCERAS LIBRA/ ELITE E2 NUEVO	INCLUDE : MATRX LIBRA CUSHION (DCA2720) MATRX ELITE/ELITE DEEP E2 BACKREST (DCA2320-DCA2350) BODYPOINT EVOFLEX BELT (DCA7810 a DCA7830) Anchura 360 mm solo posible con Profundidad 400/420 mm (NC : 1300, 1305, 1310, 1315, 1400, 1405, 1415, 1425, 2200, 2210, 2220, 2230,7230)
ASIENTO		
PARTE DELANTERA DEL CHASIS		
Ver tabla 2		
DCA1100	<input checked="" type="checkbox"/> Pescantes abatibles , chasis estándar	(NC : 1900, 1902, 3040, 3140) <input checked="" type="checkbox"/>
DCA1110	Pescantes fijos, 70° , chasis activo	(NC: 1700, 1705, 1710, 1715, 1720, 1725, 1730, 1800, 1805, 3000, 3010, 3020, 3030, 3100, 3110, 3120, 3130) <input type="checkbox"/>
DCA1120	Pescantes fijos 80° , chasis dinámico	Ángulo de asiento mínimo (FSTF vs RSTF): 30 MM (NC : 1700, 1705, 1710, 1715, 1720, 1725, 1730, 1780, 1800, 1805, 1962, 3000, 3010, 3020, 3030, 3100, 3110, 3120, 3130, 5300, 5350, 5400, 5450, 5500, 5550, 5600, 5650) <input type="checkbox"/>
DCA1130	Pescantes fijos 70° , chasis incurvado (aducción)	Plazo de entrega adicional +10 días (NC : 1300, 1305, 1700, 1705, 1710, 1715, 1720, 1725, 1730, 1800, 1805, 3000, 3010, 3020, 3030, 3100, 3110, 3120, 3130) <input type="checkbox"/>
DCA1140	Pescantes fijos 80° , chasis incurvado (aducción)	Ángulo de asiento mínimo (FSTF vs RSTF): 30 MM Plazo de entrega adicional +10 días (NC : 1300, 1305, 1700, 1705, 1710, 1715, 1720, 1725, 1730, 1780, 1800, 1805, 1962, 3000, 3010, 3020, 3030, 3100, 3110, 3120, 3130, 5550, 5600, 5650) <input type="checkbox"/>
ANCHURA ASIENTO (SW)		



Cinturón BODYPOINT EVOFLEX GRATIS!!!! por la compra del PACK 1 o 2



Código	Descripción			P.V.P €
DCA1300	280 MM	Cruceta simple	(NC : 1600, 2210, 2300 a 2357, 2490, 2710, 2720, 2740, 2742, 2744, 2746, 2748, 2750, 2860, 3020 3030, 3120, 3130, 3260, 6000, 6010, 8450)	32,45
DCA1305	300 MM	Cruceta simple	(NC : 1600, 2210, 2300 a 2357, 2490, 2710, 2720, 2740, 2742, 2744, 2746, 2750, 3020, 3030, 3120, 3130, 3260, 6000, 6010, 8450)	32,45
DCA1310	320 MM	Cruceta simple	(NC : 1600, 2300 a 2357, 2490, 2710, 2720, 2740, 2742, 2744, 2746, 2748, 2750, 3020, 3030, 3120, 3130, 3260 6000, 6010, 8450)	32,45
DCA1315	340 MM	Cruceta simple	(NC : 1600, 2300 a 2357, 2490, 2710, 2720, 2740, 2742, 2744, 2746, 2748, 2750, 3020, 3030, 3120, 3130, 6000, 6010, 8450)	○
DCA1320	360 MM	Cruceta simple	(NC : 2364, 2366, 2368, 2370, 2372, 2490, 2710, 2742, 2744 2746, 2748, 3020, 3030, 3120, 3130)	○
DCA1325	380 MM	Cruceta simple	(NC : 2366, 2368, 2370, 2372, 2490, 2742, 2744, 3020, 3030, 3120, 3130)	○
DCA1330	400 MM	Cruceta simple	(NC : 2360, 2366, 2368, 2370, 2372, 2744)	○
DCA1335	420 MM	Cruceta simple	(NC : 2360, 2362, 2368, 2370, 2372, 2746)	○
DCA1340	440 MM	Doble cruceta	(NC : 2360, 2362, 2364, 2370, 2372, 2740, 2742)	○
DCA1345	460 MM	Doble cruceta	(NC : 2360, 2362, 2364, 2372, 2740, 2742, 2744)	○
DCA1350	480 MM	Doble cruceta	(NC : 2300, 2305, 2310, 2315, 2345, 2360, 2362, 2364, 2366, 2740, 2742, 2744)	○
DCA1355	500 MM	Doble cruceta	(NC : 2210, 2300, 2305, 2310, 2315, 2345, 2360, 2362, 2364, 2366, 2368, 2740, 2742, 2744, 2746)	32,45
PROFUNDIDAD ASIENTO (SD)				
DCA1400	320 MM		(NC : 2155, 2160, 2710, 2720, 2740, 2742, 2744, 2746, 2748, 2750, 2860, 2910, 5650)	32,45
DCA1405	340 MM		(NC : 2155, 2160, 2710, 2720, 2740, 2742, 2744, 2746, 2910, 5650)	32,45
DCA1415	360 MM		(NC : 2710, 2720, 2742, 2744, 2746, 2748, 2860, 5650)	○
DCA1425	380 MM		(NC : 2720, 2744, 5650)	○
DCA1435	◆ 400 MM		(NC : 2744)	◆
DCA1445	420 MM			○
DCA1460	440 MM		(NC : 2740, 2742)	○
DCA1470	460 MM		(NC : 2740, 2742, 2744)	○
DCA1480	480 MM		(NC : 2740, 2742, 2744, 2746, 2748)	○
DCA1490	500 MM		(NC : 2710, 2740, 2742, 2744, 2746, 2748)	○
ALTURA RESPALDO (BH)				
Con respaldo MATRX BACKRESTS : Solo determina la altura de las empuñaduras				
DCA1615	300 MM		(NC : 2140, 2210, 2240, 2595)	○
DCA1620	315 MM		(NC : 2140, 2210, 2240, 2595)	○
DCA1625	330 MM		(NC : 2140, 2210, 2240, 2595)	○
DCA1630	345 MM		(NC : 2210, 2240, 2595)	○
DCA1635	360 MM		(NC : 2240, 2595)	○
DCA1640	◆ 375 MM		(NC : 2240, 2595)	◆
DCA1645	390 MM		(NC : 2240, 2595)	○
DCA1650	405 MM		(NC : 2240)	○
DCA1655	420 MM		(NC : 2240)	○
DCA1660	435 MM		(NC : 2240)	○
DCA1665	450 MM		(NC : 2240)	○
DCA1670	465 MM		(NC : 2240)	○
DCA1675	480 MM		(NC : 2240)	○
DCA1680	495 MM		(NC : 2240)	○
DCA1685	510 MM		(NC : 2240)	○
ALTURA DELANTERA ASIENTO SUELO (FSTF)				
Ver tabla 1, 5				
DCA1700	370 MM	Chasis Hemi (solo con pescantes abatibles)	(NC : 1810 to 1870, 1932 to 1962, 3030, 3130, 6000, 6010, 6410, 6420, 7600)	○
DCA1705	380 MM	Chasis Hemi (solo con pescantes abatibles)	(NC : 1815 a 1870, 1934 to 1962, 3030, 3130, 6000, 6010, 6410, 6420, 7600)	○
DCA1710	390 MM	Chasis Hemi (solo con pescantes abatibles)	(NC : 1820 a 1870, 1936 to 1962, , 3030, 3130, 6000, 6010, 6410, 6420, 7600)	○

Código	Descripción			P.V.P €
DCA1715	400 MM	Chasis Hemi (solo con pescantes abatibles)	(NC: 1825 a 1870, 1938 to 1962,, 3030,, 3130, 6000, 6010,6410, 6420, 7600)	○
DCA1720	410 MM	Chasis Hemi (solo con pescantes abatibles)	(NC : 1830 to 1870, 1940 to 1962, 3030, 3130)	○
DCA1725	420 MM	Chasis Hemi (solo con pescantes abatibles)	(NC : 1835 to 1870, 1942 to 1962)	○
DCA1730	430 MM	Chasis Hemi (solo con pescantes abatibles)	(NC : 1840 to 1870, 1944 to 1962)	○
DCA1735	440 MM	(NC : 1845 to 1870, 1946 to 1962)		○
DCA1740	450 MM	(NC : 1850 to 1870, 1948 to 1962)		○
DCA1745	460 MM	(NC : 1855 to 1870, 1950 to 1962)		○
DCA1750	470 MM	(NC : 1800, 1860 to 1870, 1952 to 1962)		○
DCA1755	480 MM	(NC : 1800, 1805, 1865, 1870, 1954 to 1962)		○
DCA1760	490 MM	(NC : 1800, 1805, 1810, 1956 to 1962)		○
DCA1765	◆ 500 MM	(NC : 1800, 1805, 1810, 1815, 1958 to 1962)		◆
DCA1770	510 MM	(NC: 1800 to 1820, 1960, 1962)		○
DCA1775	520 MM	(NC: 1800 to 1825, 1962)		○
DCA1780	530 MM	(NC: 1800 to 1830)		○
ALTURA TRASERA ASIENTO SUELO (RSTF)				
Ver tabla 5				
DCA1805	370 MM	Solo con ruedas de 22" y pescantes abatibles	(NC: 6000, 6010, 6410, 6420, 6430, 7500, 7510, 7520)	○
DCA1810	380 MM	(NC : 6000, 6010, 6410, 6420, 6430)		○
DCA1815	390 MM	(NC : 6420, 6430)		○
DCA1820	400 MM	(NC : 6420, 6430)		○
DCA1825	410 MM	(NC : 6420, 6430)		○
DCA1830	420 MM			○
DCA1835	430 MM			○
DCA1840	440 MM			○
DCA1845	◆ 450 MM			◆
DCA1850	460 MM			○
DCA1855	470 MM			○
DCA1860	480 MM	(NC : 6400)		○
DCA1865	490 MM	(NC : 6400)		○
DCA1870	500 MM	(NC : 6000, 6010, 6400, 6410)		○
LARGO DE PIERNA (LLL)				
Ver tabla 2				
DCA1900	200 MM	(NC: 3030, 3130)		○
DCA1902	210 MM	(NC: 3030, 3130)		○
DCA1904	220 MM	(NC: 3030, 3130)		○
DCA1906	230 MM	(NC: 3030, 3130)		○
DCA1908	240 MM	(NC: 3030, 3130)		○
DCA1910	250 MM	(NC: 3030, 3130)		○
DCA1912	260 MM	(NC: 3030, 3130)		○
DCA1914	270 MM	(NC: 3030, 3130)		○
DCA1916	280 MM	(NC: 3030, 3130)		○
DCA1918	290 MM	(NC: 3030, 3130)		○
DCA1920	300 MM	(NC: 3030, 3130)		○
DCA1922	310 MM	(NC: 3030, 3130)		○
DCA1924	320 MM	(NC: 3030, 3130)		○
DCA1926	330 MM	(NC: 3030, 3130)		○
DCA1928	340 MM	(NC: 3030, 3130)		○
DCA1930	350 MM	(NC: 3030, 3130)		○
DCA1932	360 MM	(NC: 3030, 3130)		○
DCA1934	370 MM	(NC: 3030, 3130)		○
DCA1936	380 MM			○
DCA1938	390 MM			○
DCA1940	400 MM			○
DCA1942	410 MM			○
DCA1944	420 MM			○
DCA1946	◆ 430 MM			◆
DCA1948	440 MM			○
DCA1950	450 MM			○
DCA1952	460 MM			○
DCA1954	470 MM			○
DCA1956	480 MM			○
DCA1958	490 MM			○
DCA1960	500 MM			○
DCA1962	510 MM	(NC : 3000, 3100, 3010, 3110)		○

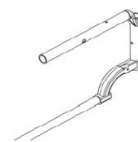

Chasis Hemi
Obligatorio con
opciones 1700 a 1730
y con pescantes
abatibles)

RSTF / FSTF : pescantes fijos

Pescantes fijos 70° :
RSTF = "FSTF- 100 mm " a "FSTF - 0 mm"
Pescantes fijos 80° :
RSTF = "FSTF - 100 mm " a "FSTF - 30 mm"

RSTF / FSTF : Pescantes abatibles

Pescantes 70° & 80° :
RSTF = "FSTF - 100 mm " a "FSTF - 0 mm"

RSTF / Tamaño rueda trasera

22" : 360-470 mm
24" : 390-490 mm
25" : 420-500 mm
26" : 420-500 mm

LLL / FSTF : Pescantes fijos

Pescantes fijos 70° :
LLL max. = "FSTF - 20 mm"
Pescantes fijos 80° :
LLL max. = "FSTF - 30 mm"

LLL / FSTF : Pescantes abatibles

Pescantes fijos 70° :
LLL max. = "FSTF 20 mm"
Pescantes fijos 80° :
LLL max. = "FSTF 30 mm"

LLL / paleta

Dependiendo de la configuración, la paleta
puede ser de montaje superior - ver tabla 2







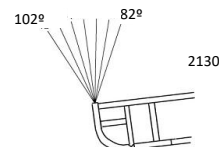
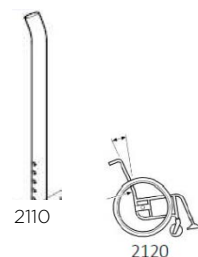









LLL / FSTF : Reposapiés elevables

Posición 75°
LLL max = FSTF -40 mm
LLL min = 380 mm
Posición 60°
LLL max = FSTF + 00 mm
LLL min = 380 mm

Código	Descripción		P.V.P €
RESPALDO			
TUBO RESPALDO			
DCA2110	◆	Tubos fijos (90°)	(NC : 2155, 2160, 2165, 2170, 2175, 2180) ◆
DCA2120		Tubos con ángulo lumbar (7°)	(NC : 2155, 2160, 2165, 2170, 2175, 2180, 2300 a 2357) 43,74
DCA2130		Respaldo ajustable en ángulo	Por favor, seleccione el ángulo BH > 330 MM Solo (NC : 2300 a 2357) 215,59
DCA2140		Respaldo ajustable en ángulo y abatible (sobre el asiento)	Por favor, seleccione el ángulo (NC : 2180, 2300 a 2357, 2430) 368,30
ANGULO RESPALDO (Con respecto al asiento)			
DCA2155		Ángulo respaldo, ajustado a 82° (hacia delante)	○
DCA2160		Ángulo respaldo, ajustado a 86°	○
DCA2165		Ángulo respaldo, ajustado a 90°	○
DCA2170		Ángulo respaldo, ajustado a 94°	No posible con respaldo abatible (DCA2140) + respaldo MATRX ○
DCA2175		Ángulo respaldo, ajustado a 98°	No posible con respaldo abatible (DCA2140) + respaldo MATRX ○
DCA2180		Ángulo respaldo, ajustado a 102° (hacia atrás)	○
TAPIZADO RESPALDO			
DCA2200	◆	Tapizado estándar, acolchado	(NC : 2300 a 2357, 2400, 2430, 2595) ◆
DCA2210		Tapizado ligero (anti transpirable)	No posible con SW ≤ 320 MM / SW 500 MM / BH < 360 MM PLAZO DE ENTREGA ADICIONAL +10 DÍAS (NC : 2300 a 2357, 2430, 2595) 159,58
DCA2220		Tapizado ajustable en tensión PREMIUM negro, bolsillo trasero	(NC : 2300 a 2357) 119,00
DCA2230		Tapizado ajustable en tensión Aero back, transpirable, bolsillo trasero	UNIQUE: PERSONALIZACIÓN DE ESTAMPADO, COSTURAS O BORDADO POSIBLES (NC : 2300 a 2357) 200,41
DCA2240		Sin tapizado de respaldo	Obligatorio para seleccionar respaldo a medida tipo Matrx (NC: 2430, 2595) ○
UNIQUE - COSTURA PERSONALIZADA TAPIZADO RESPALDO - SOLO CON OPCIÓN AERO-BACK (2230)			
UCA2241		Amarillo Neon	160,00
UCA2242		Rosa Neon	160,00
UCA2243		Azul	160,00
UCA2244		Blanco	160,00
UCA2245		Rojo	160,00
UCA0002		Color personalizado - Contactar con Departamento de Atención al Cliente	SOLO FABRICACIÓN ESPECIAL (DCA0000)
UNIQUE - BORDADO TAPIZADO RESPALDO - SOLO CON OPCIÓN AERO-BACK (2230)			
UCA2246		Smiley	280,00
UCA2248		Aventurero	280,00
UCA2249		Belleza Sakura	280,00
UCA2250		Cactus sonriente	280,00
UCA2251		LOGO KUSCHALL	280,00
UCA0003		Otro Diseño - Contactar con Departamento de Atención al Cliente - Gracias por mandarnos el diseño deseado por mail en formato .ai / .pdf o .png (alta resolución)	SOLO FABRICACIÓN ESPECIAL (DCA0000)
UNIQUE - ESTAMPADO - TAPIZADO RESPALDO - SOLO CON OPCIÓN AERO-BACK (2230)			
UCA2253		Smiley	125,00
UCA2255		Aventurero	125,00
UCA2256		Belleza Sakura	125,00
UCA2257		Cactus sonriente	125,00
UCA2259		Explosión de colores	125,00
UCA0004		Otro Diseño - Contactar con Departamento de Atención al Cliente - Gracias por mandarnos el diseño deseado por mail en formato .ai / .pdf o .png (alta resolución)	SOLO FABRICACIÓN ESPECIAL (DCA0000)



INFORMACIÓN IMPORTANTE RELACIONADA CON RESPALDOS MATRX o A MEDIDA
En caso de montar un respaldo Matrx o a medida, asegúrese que la parte más alta del respaldo no esté situada a más de 590 mm a partir del asiento

Código	Descripción	P.V.P €	
RESPALDOS MATRX			
La altura corresponde a la altura efectiva del respaldo MATRX Plazo de entrega adicional + 10 DÍAS			
DCA2300	Matrx MX2, altura 150 mm con fijación Quick-Release (par) 	No posible con SW > 460 MM y SW < 360MM Solo para usuarios hasta 113KG (NC : 2370, 2372, 2490, 7600)	770,00
DCA2305	Matrx MX2, altura 230 mm con fijación Quick-Release (par) 	No posible con SW > 460 MM y SW < 360MM Solo para usuarios hasta 113KG	770,00
DCA2310	Matrx MX2, altura 305 mm con fijación Quick-Release (par) 	No posible con SW > 460 MM y SW < 360MM Solo para usuarios hasta 113KG	770,00
DCA2315	Matrx MX2, altura 405 mm con fijación Quick-Release (par) 	No posible con SW > 460 MM y SW < 360MM Solo para usuarios hasta 113KG	770,00
DCA2316	ELITE DEEP E2 , altura 160 mm con fijación Mini incluida (par) 	No posible con SW < 360MM	770,00
DCA2317	ELITE DEEP E2 , altura 210 mm con fijación Mini incluida (par) 	No posible con SW < 360MM	770,00
DCA2318	ELITE DEEP E2 , altura 260 mm con fijación Mini incluida (par) 	No posible con SW < 360MM	770,00
DCA2320	Elite Deep E2, altura 310 mm con fijación Mini incluida (par) 	No posible con SW < 360MM	770,00
DCA2322	ELITE DEEP E2, altura 360 mm con fijación Mini incluida (par) 	No posible con SW < 360MM	770,00
DCA2325	Elite Deep E2, altura 410 mm con fijación Mini incluida (par) 	No posible con SW < 360MM	770,00
DCA2330	Elite Deep E2, altura 460 mm con fijación Estándar incluida (par) 	No posible con SW < 360MM	770,00
DCA2331	ELITE DEEP E2, altura 510 mm con fijación Estándar incluida (par) 	No posible con SW < 360MM	770,00
DCA2332	ELITE E2, altura 160 mm con fijación Mini incluida (par) 	No posible con SW < 360MM	770,00
DCA2334	ELITE E2, altura 210 mm con fijación Mini incluida (par) 	No posible con SW < 360MM	770,00
DCA2335	Elite E2, altura 260 mm con fijación Mini incluida (par) 	No posible con SW < 360MM	770,00
DCA2340	Elite E2, altura 310 mm con fijación Mini incluida (par) 	No posible con SW < 360MM	770,00
DCA2345	Elite E2, altura 360 mm con fijación Mini incluida (par) 	No posible con SW > 460 MM y SW < 360MM	770,00
DCA2350	Elite E2, 410 mm con fijación Mini incluida (par) 	No posible con SW < 360MM	770,00
DCA2355	ELITE E2, altura 460 mm con fijación Estándar incluida (par)	No posible con SW < 360MM	770,00
DCA2357	ELITE E2, altura 510 mm con fijación Estándar incluida (par)	No posible con SW < 360MM	770,00
ANCHURA RESPALDO MATRX			
DCA2360	360 MM	Anchora de tronco (indicativa) : 265 MM	<input type="radio"/>
DCA2362	380 MM	Anchora de tronco (indicativa) : 290 MM	<input type="radio"/>
DCA2364	410 MM	Anchora de tronco (indicativa) : 315 MM	<input type="radio"/>
DCA2366	430 MM	Anchora de tronco (indicativa) : 340 MM	<input type="radio"/>
DCA2368	460 MM	Anchora de tronco (indicativa) : 370 MM	<input type="radio"/>
DCA2370	480 MM	Anchora de tronco (indicativa) : 390 MM	<input type="radio"/>
DCA2372	510 MM	Anchora de tronco (indicativa) : 420 MM	<input type="radio"/>
PUÑOS DE EMPUJE			
DCA2400	Sin puños	Con respaldo Matrx : montaje a 350 mm desde asiento (aprox)	(NC : 2490) <input type="radio"/>
DCA2410	Puños fijos, mini	Con respaldo Matrx : montaje a 475 mm desde asiento (aprox)	(NC :2490, 6580) 59,05
DCA2420	◆ Puños fijos , largos	Con respaldo Matrx : montaje a 475 mm desde asiento (aprox)	◆



2300-2315

Elite E2

















2410 2420 2450



2440 2430



Código	Descripción			P.V.P €
DCA2430	Puños ajustables en altura, montaje trasero	Con respaldo MatrX : montaje a 600 mm desde asiento (aprox)	(NC : 2490, 3520, 3620)	240,01
DCA2440	Puños ajustables en altura, integrados		(NC : 2490, 2595)	216,99
DCA2450	Puños plegables	Con respaldo MatrX : montaje a 450 mm desde asiento (aprox)	(NC : 2490, 2595, 6580)	263,06
REPOSACAEBZAS				
DCA2490	Reposacabezas envolvente 		(NC : 2595, 6580)	147,36
BARRA ESTABILIZADORA RESPALDO				
DCA2595	Barra estabilizadora de respaldo, abatible y desmontable	No posible con BH \leq 390 MM		150,33
ASIENTO				
TAPIZADO ASIENTO				
DCA2610		Tapizado estándar con una cincha central con cierre gancho-bucle (suave)	UNIQUE: PERSONALIZACIÓN DE COSTURA POSIBLE	
DCA2620		Tapizado con una cincha central con cierre gancho-bucle (suave) y dos cinchas en las partes laterales (rugosas)		27,04
UNIQUE - COSTURA PERSONALIZADA TAPIZADO ASIENTO				
UCA2602	Amarillo Neon			190,00
UCA2603	Rosa Neon			190,00
UCA2604	Azul			190,00
UCA2605	Blanco			190,00
UCA2606	Rojo			190,00
UCA0005	Color personalizado - Contactar con Departamento de Atención al Cliente	SOLO FABRICACIÓN ESPECIAL (DCA0000)		
COJÍN ASIENTO				
DCA2700	Cojín asiento estándar, 60 mm, espuma doble con visco top		(NC : 2810, 2820, 2830, 2840, 2850)	91,87
DCA2710	MATRX FLO-TECH LITE - Altura 78 mm 		(NC : 2810, 2820, 2830, 2840, 2850)	105,43
DCA2720	MATRX LIBRA (tejido negro) - altura 83 mm 	No posible con SW \leq 340 MM & SD \leq 380 MM	SW 360 MM Solo posible con SD 400/420 MM Plazo de entrega adicional +7 días	(NC : 2810, 2820, 2830, 2840, 2850) 323,15
DCA2740	CLASSIC VISCO 375 X 400 MM - altura 75 mm 	Solo para usuarios hasta 50 KG		(NC : 2810, 2820, 2830, 2840, 2850) 105,43
DCA2742	CLASSIC VISCO 405 X 400 MM - altura 75 mm 	Solo para usuarios hasta 100 KG		(NC : 2810, 2820, 2830, 2840, 2850) 105,43
DCA2744	CLASSIC VISCO 430 X 430 MM - altura 75 mm 	Solo para usuarios hasta 100 KG		(NC : 2810, 2820, 2830, 2840, 2850) 105,43
DCA2746	CLASSIC VISCO 455 X 400 MM - altura 75 mm 	Solo para usuarios hasta 100 KG		(NC : 2810, 2820, 2830, 2840, 2850) 105,43
DCA2748	CONTOUR VISCO NG altura 100 mm 			(NC : 2810, 2820, 2830, 2840, 2850) 105,43
BOLSA DE ASIENTO				
DCA2800	Bolsa asiento delantera, desmontable			74,49
ACCESORIOS MATRX LIBRA				
BASE RÍGIDA				
DCA2860	Base rígida 			46,81
BOLSA TAPIZADO DE ASIENTO				
DCA2910	Bolsa grande de tela (fijación cinchas cierre gancho-bucle) debajo del tapizado de asiento	No posible con SD \leq 340 MM		59,95
REPOSAPIÉS Y PALETAS				
PESCANTES ABATIBLES				
Ver tabla 2, 6				
PESCANTE DERECHO				
DCA3000	Pescante derecho, abatible y desmontable 70° (ángulo abierto)	Paletas obligatorias	(NC : 3110)	
DCA3010		Pescante derecho, abatible y desmontable 80° (ángulo semi abierto)	Paletas obligatorias	(NC : 3100, 5650) 
DCA3020	Soporte amputado, derecho		(NC : 3280, 3300, 3305, 3310)	155,98



2595



2720



2700



2800



2860



2910



3020 / 3120

Código	Descripción			P.V.P €
DCA3030	Reposapiernas derecho, ajustable en ángulo 0° a 75° con apoya pantorrilla ajustable, UL desde 380 hasta 580 mm	Paleta ajustable en ángulo, profundidad y anchura	(NC : 3280, 3300, 3305, 3310)	142,69
DCA3040	Pescante fijo derecho	Solo si opción 1130 o 1140 seleccionada		○
PESCANTE IZQUIERDO				
DCA3100	Pescante izquierdo, abatible y desmontable 70° (ángulo abierto)	Paletas obligatorias		○
DCA3110	◆ Pescante izquierdo, abatible y desmontable 80° (ángulo semi abierto)	Paletas obligatorias	(NC : 5650)	◆
DCA3120	Soporte amputado, izquierdo		(NC : 3280, 3300, 3305, 3310)	155,98
DCA3130	Reposapiernas izquierdo, ajustable en ángulo 0° a 75° con apoya pantorrilla ajustable, UL desde 380 hasta 580 mm	Paleta ajustable en ángulo, profundidad y anchura	(NC : 3280, 3300, 3305, 3310)	142,69
DCA3140	Pescantes fijos izquierdo	Solo si opción 1130 o 1140 seleccionada		○
PALETAS DOBLES O MONOBLOC				
PALETA				
DCA3260	◆ 2 piezas abatibles, composite - Nueva!	No posible con SW < 340 MM, LLL < 260 MM, chasis incurvado (aducción) SW < 380 MM		◆
DCA3270	2 piezas abatibles, ajustables en ángulo y profundidad, carbono		(NC : 3310)	253,03
DCA3280	1 pieza- ajustable en ángulo y abatible, carbono	No posible con LLL < 300 MM	(NC : 3310)	272,50
SOPORTE PARA LOS PIES				
DCA3300	Cincha apoya pantorrilla montada en el chasis			○
DCA3305	Cincha apoya pantorrilla montada en la parte trasera de los pescantes			○
DCA3310	◆ Taloneras (par)			◆
REPOSABRAZOS/PROTECTORES/ANTISALPICADURAS				
PROTECTORES DE ROPA, ANTISALPICADURAS Ver tabla 3				
DCA3400	Protectores de ropa de composite, fijos - Nuevo! INCREMENTA EL ANCHO DE ASIENTO ENTRE 0 Y 10 MM	UNIQUE: color transparente o NEON posibles	(NC: 3500, 3510, 3530, 3540, 3550, 3600, 3610, 3630, 3640, 3650, 7600, 8450)	○
DCA3405	Protectores de ropa desmontables, composite ¡Nuevos! REDUCE EL ANCHO DE ASIENTO ENTRE 0 Y 10 MM	UNIQUE: color transparente o NEON posibles	(NC : 3500, 3510, 3530, 3540, 3550, 3600, 3610, 3630, 3640, 3650, 7600, 8450)	○
DCA3410	Protectores de ropa de carbono, fijos - Nuevo! INCREMENTA EL ANCHO DE ASIENTO ENTRE 0 Y 10 MM		(NC : 3500, 3510, 3530, 3540, 3550, 3600, 3610, 3630, 3640, 3650, 7600, 8450)	75,71
DCA3425	◆ Protectores de ropa antisalpicaduras de composite, fijos - Nuevo! INCREMENTA EL ANCHO DE ASIENTO ENTRE 0 Y 10 MM		(NC : 3500, 3510, 3530, 3540, 3550, 3600, 3610, 3630, 3640, 3650, 6000, 6010, 6140, 6580, 6950, 7600, 8450)	◆
DCA3430	Protectores de ropa antisalpicaduras de carbono, fijos - Nuevo! INCREMENTA EL ANCHO DE ASIENTO ENTRE 0 Y 10 MM	No posible con FSTF < 410 MM	(NC : 3500, 3510, 3530, 3540, 3550, 3600, 3610, 3630, 3640, 3650, 6000, 6010, 6140, 6150, 6580, 6950, 7600, 8450)	86,52
DCA3440	Protectores de ropa antisalpicaduras de carbono, desmontables - Nuevo! REDUCE EL ANCHO DE ASIENTO ENTRE 0 Y 10 MM	Incrementa ancho total: + 20 mm	(NC : 3500, 3510, 3530, 3540, 3550, 3600, 3610, 3630, 3640, 3650, 6140, 6150, 8450)	151,41
DCA3450	Protectores de ropa antisalpicaduras de composite, desmontables - Nuevo! REDUCE EL ANCHO DE ASIENTO ENTRE 0 Y 10 MM	Incrementa ancho total: + 20 mm	(NC : 3500, 3510, 3530, 3540, 3550, 3600, 3610, 3630, 3640, 3650, 6000, 6010, 6140, 6150, 6580, 6950, 8450)	64,89



3030 / 3130

Reposapiés :
Tome nota que los reposapiés especiales como el reposapiés para amputado solo son compatibles con anchuras > 380 mm.



3260



3270



3280



3400



3430



3440



3450



3400

Atención:
El reposabrazos hemi viene montado en el reposabrazos REA y no en reposabrazos Küschall

Código	Descripción		P.V.P €
UNIQUE - Colores transparentes - Sólo para protectores de ropa de composite (3400,3405)			
UCA3422	Transparente		550,00
UCA3423	Azul Transparente		790,00
UCA3424	Amarillo Neon		790,00
UCA3425	Naranja Neon		790,00
UCA3426	Rojo Neon		790,00
UCA0006	Otro color - Contactar con Departamento de Atención al Cliente		SOLO FABRICACIÓN ESPECIAL (DCA0000)
UCA0007	Otro diseño - Contactar con Departamento de Atención al Cliente - Gracias por mandarnos el diseño deseado por mail en formato .ai / .pdf o .png (alta resolución)		SOLO FABRICACIÓN ESPECIAL (DCA0000)
REPOSABRAZOS DERECHO			
DCA3500	Reposabrazos ajustables en altura (con herramienta), desmontable, corto, sin bloqueo, incluye protector de ropa de carbono		117,62
DCA3510	Reposabrazos ajustables en altura (con herramienta), desmontable, largo, sin bloqueo, incluye protector de ropa de carbono		(NC : 6950, 8450) 117,62
DCA3520	Reposabrazos tubular, sin bloqueo, ajustable en altura, desmontable, abatible, acolchado confort		(NC : 6950) 117,62
DCA3530	Reposabrazos Kuschall, contorno negro, sistema bloqueo, ajustable en altura, desmontable, abatible, almohadilla corta (incluye funda neopreno negra)		(NC : 6130, 6140, 6150) 133,51
DCA3540	Reposabrazos HEMI (Rea), ajustable en altura, desmontable, abatible, acolchado Hemi y funda de neopreno negro		(NC : 6130, 6140, 6150, 8450) 173,04
REPOSABRAZOS IZQUIERDO			
DCA3600	Reposabrazos ajustables en altura (con herramienta), desmontable, corto, sin bloqueo, incluye protector de ropa de carbono		117,62
DCA3610	Reposabrazos ajustables en altura (con herramienta), desmontable, largo, sin bloqueo, incluye protector de ropa de carbono		117,62
DCA3620	Reposabrazos tubular, sin bloqueo, ajustable en altura, desmontable, abatible, acolchado confort		(NC : 6950, 8450) 117,62
DCA3630	Reposabrazos Kuschall, contorno negro, sistema bloqueo, ajustable en altura, desmontable, abatible, almohadilla corta (incluye funda neopreno negra)		(NC : 6130, 6140, 6150) 133,51
DCA3640	Reposabrazos HEMI (Rea), ajustable en altura, desmontable, abatible, acolchado Hemi y funda de neopreno negro		(NC : 6130, 6140, 6150, 8450) 173,04
COLORES DE CHASIS Y PERSONALIZACIÓN (ver configurador visual Kuschall para personalizar su silla K-series)			
COLOR DE CHASIS			
DCA4000	Negro espacial (RAL 9005)		Personalización con calcomanía BOLD o TAG
DCA4010	Gris antracita (RAL 7016)		Personalización con calcomanía BOLD o TAG
DCA4020	Blanco puro (RAL 9016)		Personalización con calcomanía BOLD o TAG (NC : 4220)
DCA4030	Rojo Carmin (RAL 3002)		Personalización con calcomanía BOLD o TAG
DCA4040	Azul Celeste (RAL 5017)		Personalización con calcomanía BOLD o TAG
DCA4060	Amarillo intenso (RAL 1016)	Plazo de entrega adicional +15 días	Personalización con calcomanía BOLD o TAG
DCA4100	Negro brillante (RAL 9005)	Plazo de entrega adicional +15 días	Personalización con calcomanía BOLD o TAG
DCA4130	Gris plateado (RAL 9006)	Plazo de entrega adicional +15 días	Personalización con calcomanía BOLD o TAG
DCA4145	Azul Noche Perlado NUEVO	Plazo de entrega adicional +15 días	Personalización con calcomanía BOLD o TAG
DCA4150	Rojo rubí (RAL 3003)	Plazo de entrega adicional +15 días	Personalización con calcomanía BOLD o TAG
DCA4170	Naranja dinamita	Plazo de entrega adicional +15 días	Personalización con calcomanía BOLD o TAG
DCA4180	Verde forestal (RAL 6029)	Plazo de entrega adicional +15 días	Personalización con calcomanía BOLD o TAG
UCA4101	Espejo pulido	ACABADO ESMALTADO CERÁMICO DISPONIBLE	NC : 4200 a 4250, 4300, 4310 799,00



3600/3610

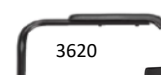

3620



3640



3530/3630

Atención:
El reposabrazos hemi viene montado en el reposabrazos REA y no en reposabrazos Kuschall

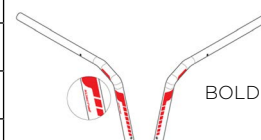

BOLD

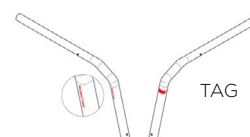

TAG



Código	Descripción			P.V.P €
UCA4102	Verde pastel	ACABADO ESMALTADO CERÁMICO DISPONIBLE	NC : 4200 a 4250, 4300, 4310	750,00
UCA4103	Azul claro	ACABADO ESMALTADO CERÁMICO DISPONIBLE	NC : 4200 a 4250, 4300, 4310	750,00
UCA4104	Ciruela morado	ACABADO ESMALTADO CERÁMICO DISPONIBLE	NC : 4200 a 4250, 4300, 4310	750,00
UCA4105	Salmón	ACABADO ESMALTADO CERÁMICO DISPONIBLE	NC : 4200 a 4250, 4300, 4310	750,00
UCA0008	Otro color - Contactar con Departamento de Atención al Cliente	SOLO FABRICACIÓN ESPECIAL (DCA0000)	PLAZO DE ENTREGA ADICIONAL +15 DÍAS	
UNIQUE - ACABADO ESMALTADO CERÁMICO				
UCA4066	Acabado esmaltado cerámico	Solo para colores UCA4101 a UCA4105		680,00
ESTILO DE CALCOMANÍA				
DCA4190	BOLD	Colores UNIQUE DISPONIBLES	(NC : 4300, 4310)	102,74
DCA4195	◆ TAG		(NC : 4200, 4210, 4220, 4230, 4240, 4250)	◆
DCA4197	Sin Calcomanía (solo Logo Kuschall)		(NC : 4200, 4210, 4220, 4230, 4240, 4250, 4300, 4310)	○
Color de calcomanía BOLD (calcomanías en la parte delantera de los flancos)				
DCA4200	Negro			○
DCA4210	Gris oscuro			○
DCA4220	Gris claro			○
DCA4230	Rojo			○
DCA4240	Azul			○
DCA4250	Dorado			○
UCA4252	Amarillo Neon	Pegatina en lugar de calcomanía		190,00
UCA4253	verde Neon	Pegatina en lugar de calcomanía		190,00
UCA4254	Naranja Neon	Pegatina en lugar de calcomanía		190,00
UCA4255	Rosa Neon	Pegatina en lugar de calcomanía		190,00
UCA4256	Rojo Neon	Pegatina en lugar de calcomanía		190,00
UCA0009	Otro color - Contactar con Departamento de Atención al Cliente	SOLO FABRICACIÓN ESPECIAL (DCA0000)		
TAG COLOR				
DCA4300	Negro		(NC : 4300, 4310)	○
DCA4310	Rojo		(NC : 4200, 4210, 4220, 4230, 4240, 4250)	○
DCA4197	Sin calcomanía, Solo logo Kuschall		(NC : 4200, 4210, 4220, 4230, 4240, 4250, 4300, 4310)	
RUEDAS DELANTERAS				
Ver tabla 1				
DCA5050	4" Everyday cubierta negra			○
DCA5100	4" Confort cubierta negra			○
DCA5150	4" Starec llanta negra, cubierta negra			104,99
DCA5200	4" Froglegs con llanta de aluminio negro, cubierta negra	UNIQUE - COLOR BUJE RUEDA FROGLEGS / RODAMIENTOS DE CERAMICA DISPONIBLES		104,99
DCA5250	4" Froglegs con llanta de aluminio plata, cubierta negra	UNIQUE - RODAMIENTOS DE CERAMICA DISPONIBLES		104,99
DCA5300	5" Everyday con cubierta negra			○
DCA5350	◆ 5" Confort con cubierta negra			◆
DCA5400	5" Starec llanta negra, cubierta negra			111,56
DCA5450	5" Froglegs con llanta de aluminio negro, cubierta negra	UNIQUE - COLOR BUJE RUEDA FROGLEGS / RODAMIENTOS DE CERAMICA DISPONIBLES		111,56
DCA5500	5" Froglegs con llanta de aluminio plata, cubierta negra	UNIQUE - RODAMIENTOS DE CERAMICA DISPONIBLES		111,56
DCA5550	6" Confort con cubierta negra			○
DCA5600	6" neumática			35,69
DCA5650	7" Confort con cubierta negra			○
UNIQUE - COLOR BUJE RUEDA FROGLEGS				
UCA5502	Rosa			220,00
UCA5504	Naranja			220,00
UCA5506	Azul			220,00
UCA5507	Púrpura			220,00
UCA5508	Rojo			220,00
UCA5509	Dorado			220,00



Código	Descripción		P.V.P €
UNIQUE - RODAMIENTOS DE CERAMICA			
UCA5510	Rodamientos de cerámica	Solo para colores UCA5502 a 5509	105,00
RUEDAS TRASERAS			
DOBLE ARO			
DCA6000	DOBLE ARO LADO DERECHO (con rueda ligera 7 bares, aros de aluminio)	(NC : 6040, 6130, 6140, 6150, 6300, 6400, 6420, 6430, 6500, 6510, 6520, 6550, 6551, 6552, 6553, 6554, 6580, 6680, 6840, 6900, 6910, 6950, 8650, 8680)	515,00
DCA6010	DOBLE ARO LADO IZQUIERDO (con rueda ligera 7 bares, aros de aluminio)	(NC : 6040, 6130, 6140, 6150, 6300, 6400, 6420, 6430, 6500, 6510, 6520, 6550, 6551, 6552, 6553, 6554, 6580, 6680, 6840, 6900, 6910, 6950, 8650, 8680)	515,00
FIJACIÓN RUEDA TRASERA			
DCA6020	◆ Fijación estándar	(NC : 6140, 6150)	◆
DCA6040	Extensión rueda trasera	(NC: 6100, 6950)	86,61
POSICIÓN RUEDA TRASERA			
DCA6100	1a posición (la más activa)	(NC : 6580, 6840)	○
DCA6110	2a posición	(NC : 6950)	○
DCA6120	◆ 3a posición		◆
DCA6130	4a posición	(NC : 6950)	○
DCA6140	5a posición (solo con opción 6040)		○
DCA6150	6a posición (la más estable) - (Solo con opción 6040)		○
EJE DE DESMONTAJE RÁPIDO PARA TETRAS			
DCA6300	Eje de desmontaje rápido TETRA-CLIP	(NC: 6550, 6551, 6552, 6553, 6554, 6580, 6950)	114,36
TAMAÑO RUEDAS TRASERAS			
DCA6400	22"	(NC : 6500, 6520, 6550, 6551, 6552, 6553, 6554, 6560, 6600, 6630, 6660, 6760, 6710 6720, 6740, 6750, 6760, 6770, 6950)	226,41
DCA6410	◆ 24"	(NC : 6640)	◆
DCA6420	25"	(NC: 6500, 6510, 6580, 6600, 6525, 6640, 6660, 6700, 6710, 6720, 6760, 6770, 6900, 6910, 6950)	226,41
DCA6430	26"	(NC : 6500, 6520, 6550, 6551, 6552, 6553, 6554, 6600, 6630, 6660, 6720, 6740, 6750, 6760, 6770, 6840, 6950)	226,41
TIPO DE RUEDAS TRASERAS			
DCA6500	◆ Ruedas activas 24" (llantas, buje y radios radiales -negros - aros aluminio, neumáticos presión 7.5 bares)	Otros tipos de cubiertas posibles	(NC 6625 : todos los aros, todos los protectores de radios)
DCA6510	STAREC 22", 24", 26" radios Cruzados	Llanta negra y buje negro, radios cruzados negros para ruedas 24" y 26" / buje natural, radios color plata para ruedas 22", (NC 6625)	○
DCA6520	Ruedas PERFORMANCE 24", 25", llanta negra, buje Starec negro, radios cruzados negros	NC : 6660	369,53
DCA6550	Ruedas SPINERGY LXX 24", 25", llanta negra, buje negro, radios radiales negros	UNIQUE - Colores de radios disponibles UNIQUE - colores de rodamientos disponibles	(NC : 6625, 6660,, 6910)
UCA6551	24", 25" SPINERGY LITE EXTREME LX (llanta, buje y radios radiales negros) - 680g por rueda	UNIQUE - Color personalizado Llanta, buje, radios, posible UNIQUE - Rodamientos de cerámica, posible	(NC : 6660, 6910, 7900, 7910)
UCA6552	24", 25" SPINERGY LITE EXTREME X-LACED XLX (llanta, buje y radios cruzados negros) - 660g por rueda	UNIQUE - Color personalizado Llanta, buje, radios, posible UNIQUE - Rodamientos de cerámica, posible	(NC : 6660, 6910, 7900, 7910)
UCA6553	24", 25" SPINERGY X-LACED SPORT LITE EXTREME XSLX (llanta, buje y radios cruzados negros) - 757g por rueda	UNIQUE - Color personalizado Llanta, buje, radios, posible UNIQUE - Rodamientos de cerámica, posible	(NC : 6660, 6910, 7900, 7910)
UCA6554	24", 25" SPINERGY CLX - Fibra de carbono (llanta, buje y radios radiales negros) , eje Starec) - 570g por rueda	UNIQUE - Color personalizado Llanta, buje, radios, posible UNIQUE - Rodamientos de cerámica, posible	(NC : 6557, 6558, 6559, 6560, 6561, 6562, 6565, 6660, 6910, 7900, 7910)
DCA6580	22", 24", 26" freno tambor para acompañante	(NC : 6625, 6660,, 6910)	465,05



6000/6010



6020

6510



6520

6550

Código	Descripción	P.V.P €	
UNIQUE - COLOR ANODIZADO LLANTA RUEDA TRASERA SPINERGY			
UCA6557	Azul	250,00	
UCA6558	Dorado	250,00	
UCA6559	Verde	250,00	
UCA6560	Naranja	250,00	
UCA6561	Rojo	250,00	
UCA6562	Púrpura	250,00	
UNIQUE - COLOR ANODIZADO BUJE RUEDA TRASERA SPINERGY			
UCA6563	Azul	250,00	
UCA6564	Dorado	250,00	
UCA6565	Plata	250,00	
UCA6566	Verde	250,00	
UCA6567	Naranja	250,00	
UCA6568	Rojo	250,00	
UCA6569	Púrpura	250,00	
UNIQUE - COLOR RADIOS RUEDA TRASERA SPINERGY			
UCA6570	Azul	250,00	
UCA6571	Verde	250,00	
UCA6572	Naranja	250,00	
UCA6573	Rosa	250,00	
UCA6574	Rojo	250,00	
UCA6575	Púrpura	250,00	
UCA6576	Blanco	250,00	
UCA6577	Amarillo	250,00	
UNIQUE - RODAMIENTOS DE CERAMICA RUEDAS SPINERGY			
UCA6579	Rodamientos de cerámica	351,00	
CUBIERTA RUEDAS TRASERAS			
DCA6600	◆ 24" X 1" , MAXXIS LITE GUARD, Protección antipinchazo SilverShield polifibra (0,45 mm)	◆	
DCA6625	22", 24", 25", 26" X 1" MAXXIS ALPHA PROTECT (protección antipinchazo) 3 mm	72,18	
DCA6630	24" X 1" MBL SPEEDLITE - Neumático SUPERLIGERO, muy alta resistencia a los pinchazos	72,18	
DCA6660	24" X 1.3/8" maciza negra (NC : 6690, 7230)	72,18	
AROS DE PROPULSIÓN UNIQUE - KITS COLORES ANODIZADOS DISPONIBLES			
DCA6700	Antideslizantes 22", 24", 26" dist. 30 mm.	Lengüetas largas con 2 orificios distancia 30 o 40 mm, montados a 30 mm	161,09
DCA6710	Acero 24", 26", dist. 30 mm	Lengüetas cortas con un solo orificio, distancia 30 mm.	124,07
DCA6720	Titanio 24", dist. 30 mm	Lengüetas largas con 2 orificios distancia 30 o 40 mm, montados a 30 mm.	269,32
DCA6740	24" / 25" Carbolife Gekko (banda antideslizante), dist.30 cm (ancho total + 15 mm)	Lengüetas largas con 2 orificios distancia 30 o 40 cm, montados a 30 mm	349,80
DCA6750	24" / 25" Carbolife Gekko S (banda antideslizante), dist. 30 cm	Lengüetas largas con 2 orificios distancia 30 o 40 cm, montados a 30 mm	349,80
DCA6760	24" Carbolife CURVE L (perfil ergonómico), dist. 30 cm (ancho total + 15 mm)	Lengüetas largas con 2 orificios distancia 30 o 40 cm, montados a 30 mm.	330,12
DCA6770	24" Carbolife QUADRO, (perfil ergonómico y antideslizante) dist. 3 CM	Lengüetas largas con 2 orificios distancia 30 o 40 cm, montados a 30 mm	349,80
DCA6780	Aluminio ligero gris 22", 24", 25", 26" , dist. 30 mm. - KITS COLORES ANODIZADOS N°2 DISPONIBLE	Lengüetas largas con 2 orificios distancia 30 o 40 mm, montados a 30 mm.	○
DCA6790	Aluminio ligero negro 22", 24", 25", 26" , dist. 30 mm.	Lengüetas cortas con un solo orificio, distancia 30 mm.	○
CAIDA RUEDAS TRASERAS (CAMBER)			
DCA6820	◆ Caída 0°	◆	
DCA6840	Caída 3° (NC : 7230)	○	
PROTECTORES RADIOS			
DCA6900	Transparentes 22", 24", 26"	161,92	
DCA6910	Negros 22", 24", 26"	161,92	
KIT DE FIJACIÓN ALBER			
DCA6950	Kit de fijación E-MOTION	2 antivuelcos abatibles ALBER incluidos / Solo con ruedas 24" (NC : 7500, 7510, 7520, 8100, 8110, 8120, 8200, 8210)	625,48



6625

6600

ETRTO

LENCO PRIMO SENTINEL :
 22" : 25-489
 24" : 25-540
 25" : 25-559
 26" : 25-590

MAXXIS LIGHT GUARD :
 24" : 25-540

MBL SPEEDLITE :
 24" : 25-540



6630

6660

6790

6600

6780/6800

6700

6710

6720/6730

6740/ 6750

6760

6770

6900

6910

Código	Descripción		P.V.P €
UNIQUE - KITS COLORES ANODIZADOS			
UCA6960	UNIQUE - KIT 1 - PERSONALIZACIÓN COLOR HORQUILLA & TAPA RODAMIENTO		200,00
UCA6961	UNIQUE - KIT 2 - PERSONALIZACIÓN COLOR HORQUILLA, TAPA RODAMIENTO, SOPORTE HORQUILLA, SOPORTE RUEDA TRASERA, ABRAZADERA DE FRENO, PALANCA/R REPOSAPIÉS		410,00
UNIQUE - COLORES ANODIZADOS PREMIUM			
UCA6963	Rojo		○
UCA6964	Púrpura		○
UCA6965	Cobre		○
UCA6966	Verde		○
UCA6967	Naranja		○
UCA6968	Dorado		○
UCA6969	Champagne		○
UCA6970	Rosa		○
UCA6971	Azul		○
UCA6972	Acabado Espejo pulido		○
SEGURIDAD			
FRENOS			Ver tabla 4
DCA7200	◆	Frenos de tiro	◆
DCA7210		Frenos estándar, palanca angulada	○
DCA7220		Frenos estándar, palanca recta	○
DCA7230		Frenos performance	(NC : 7300, 7810, 7820, 7830)
DCA7240		Frenos activos	81,03
DCA7250		Frenos activos ligeros	(NC : 7300)
PROLONGADOR PALANCA DE FRENO			
DCA7300		Prolongador palanca de freno	75,91
OPCIONES DE SEGURIDAD			
ANTIVUELCO			
Max. 2 adaptaciones por lado (adaptaciones = antivuelco, pisapié, soporte para bastones, ruedas transit)			
DCA7500		Antivuelco derecho	157,36
DCA7510		Antivuelco izquierdo	157,36
DCA7520		Antivuelco ambos lados	314,72
KIT DE TRANSPORTE			
DCA7600		Kit de transporte, incluye 4 pegatinas	No posible con BH ≤ 400 MM (NC : 7800)
CINTURÓN POSTURAL			
DCA7800		Cinturón postural estándar	97,04
DCA7810		Cinturón postural BODYPOINT EVOFLEX 2 puntos, S, FLAT-MOUNT con hebilla estándar	113,72
DCA7820		Cinturón postural BODYPOINT EVOFLEX 2 puntos, M, FLAT-MOUNT con hebilla REHAB	113,72
DCA7830		Cinturón postural BODYPOINT EVOFLEX 2 puntos, L, FLAT-MOUNT con hebilla REHAB	113,72
ILUMINACIÓN PASIVA			
DCA7900		Iluminación pasiva (montada en los radios)	19,47
DCA7910		Iluminación pasiva sin montar	10,82
OPCIONES ACOMPAÑANTE			
PROTECTOR DE CHASIS			
DCA8000	◆	Protectores chasis (parte trasera), par	◆
DCA8010		Protectores chasis (parte delantera), par	39,38
PISAPIÉ Max. 2 adaptaciones por lado (adaptaciones = antivuelco, pisapié, soporte para bastones, ruedas transit)			
DCA8100		Pisapié derecho	(NC : 8200)
DCA8110		Pisapié izquierdo	(NC : 8210)
DCA8120		Pisapié ambos lados	(NC : 8200, 8210)
SOPORTE PARA BASTONES			
Max. 2 adaptaciones por lado (adaptaciones = antivuelco, pisapié, soporte para bastones, ruedas transit)			
DCA8200		Soporte para bastones, montaje derecha	86,61
DCA8210		Soporte para bastones, montaje izquierda	86,61
RUEDAS TRANSIT Max. 2 adaptaciones por lado (adaptaciones = antivuelco, pisapié, soporte para bastones, ruedas transit)			
DCA8300		Ruedas transit 3"	201,76
OTRAS OPCIONES			
DCA8450		Mesita (solo con reposabrazos ajustables en altura)	519,86
DCA8500		Bomba de hinchado - Nuevo	19,67
DCA8550		Kit de herramientas	16,22
DCA8650		Bolsa de transporte ruedas traseras (22", 24", 25", 26")	62,06



Código	Descripción		P.V.P €
DCA8680	Ruedas Mountain Bike 24" con bolsa de transporte	Ruedas Mountain Bike ,cubiertas y aros de aluminio grises, ejes Quick release incluidos	486,68
DCA8800	Panel pantorrilla BODYPOINT		81,11
DCA8850	Bolsa movilidad BODYPOINT		91,93

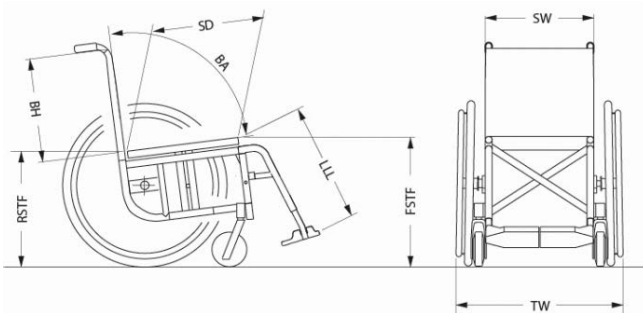

SW	Anchura de asiento
TW	Anchura total
BA	Ángulo de respaldo
BH	Altura de respaldo
SD	Profundidad de asiento
LLL	Largo de pierna
RSTF	Altura de asiento trasera
FSTF	Altura de asiento delantera

TABLA 1: Diámetro rueda delantera y altura de asiento delantera CHASIS ESTÁNDAR

Chasis	Montaje superior				Montaje estándar			
	4"	5"	6"	7"	4"	5"	6"	7"
Rueda delantera								
FSTF 380								
FSTF 390								
FSTF 400								
FSTF 410								
FSTF 420								
FSTF 430								
FSTF 440								
FSTF 450								
FSTF 460								
FSTF 470								
FSTF 480								
FSTF 490								
FSTF 500								
FSTF 510								
FSTF 520								
FSTF 530								
FSTF 540								
FSTF 550								

CHASIS HEMI *

Chasis	Montaje superior				Montaje estándar			
	4"	5"	6"	7"	4"	5"	6"	7"
FSTF 380	Green	Red	Red	Red	Red	Red	Red	Red
FSTF 390	Green	Red	Red	Red	Red	Red	Red	Red
FSTF 400	Green	Red	Red	Red	Red	Red	Red	Red
FSTF 410	Green	Green	Red	Red	Green	Red	Red	Red
FSTF 420	Green	Green	Red	Red	Green	Red	Red	Red
FSTF 430	Green	Green	Green	Red	Green	Red	Red	Red
FSTF 440	Green	Green	Green	Red	Green	Green	Red	Red
FSTF 450	Green	Green	Green	Red	Green	Green	Red	Red
FSTF 460	Green	Green	Green	Green	Green	Green	Red	Red
FSTF 470	Red	Green	Green	Green	Green	Green	Red	Red
FSTF 480	Red	Red	Green	Green	Green	Green	Red	Red
FSTF 490	Red	Red	Red	Green	Green	Green	Red	Red
FSTF 500	Red	Red	Red	Green	Red	Green	Red	Red
FSTF 510	Red	Red	Red	Red	Red	Red	Green	Red
FSTF 520	Red	Red	Red	Red	Red	Red	Red	Green
FSTF 530	Red	Red	Red	Red	Red	Red	Red	Red
FSTF 540	Red	Red	Red	Red	Red	Red	Red	Red
FSTF 550	Red	Red	Red	Red	Red	Red	Red	Red

* Solo para pescantes abatibles

CHASIS HEMI *

Rueda delantera	4"	5"	6"	7"
FSTF 380	Hemi	Red	Red	Red
FSTF 390	Hemi	Red	Red	Red
FSTF 400	Hemi	Red	Red	Red
FSTF 410	Hemi	Hemi	Red	Red
FSTF 420	Hemi	Hemi	Red	Red
FSTF 430	Hemi	Hemi	Hemi	Red
FSTF 440	Std	Hemi	Hemi	Red
FSTF 450	Std	Hemi	Hemi	Red
FSTF 460	Std	Hemi	Hemi	Hemi
FSTF 470	Std	Std	Hemi	Hemi
FSTF 480	Std	Std	Hemi	Hemi
FSTF 490	Std	Std	Std	Hemi
FSTF 500	Std	Std	Std	Hemi
FSTF 510	Std	Std	Std	Hemi
FSTF 520	Std	Std	Std	Std
FSTF 530	Std	Std	Std	Std
FSTF 540	Red	Red	Red	Red
FSTF 550	Red	Red	Red	Red

TABLA 2: MONTAJE PALETA (paleta, ángulo reposapiés, Largo de piernas)

STD Paleta montaje estándar
 SUPERIOR Paleta montaje superior
 Green Configuración posible
 Red No Compatible

	Paleta estándar de composite				Paleta de carbono 1 - 2 partes			
	Abatibles		Fijos		Abatibles		Fijos	
	70°	80°	70°	80°	70°	80°	70°	80°
LLL 200	Red	Red	SUPERIOR	SUPERIOR	Red	Red	SUPERIOR	SUPERIOR
LLL 210	Red	Red	SUPERIOR	SUPERIOR	Red	SUPERIOR	SUPERIOR	SUPERIOR
LLL 220	Red	Red	SUPERIOR	SUPERIOR	SUPERIOR	SUPERIOR	SUPERIOR	SUPERIOR
LLL 230	Red	Red	SUPERIOR	SUPERIOR	SUPERIOR	SUPERIOR	SUPERIOR	SUPERIOR
LLL 240	Red	SUPERIOR	SUPERIOR	SUPERIOR	SUPERIOR	SUPERIOR	SUPERIOR	SUPERIOR
LLL 250	Red	SUPERIOR	SUPERIOR	SUPERIOR	SUPERIOR	SUPERIOR	SUPERIOR	SUPERIOR
LLL 260	SUPERIOR	SUPERIOR	SUPERIOR	SUPERIOR	SUPERIOR	SUPERIOR	SUPERIOR	SUPERIOR
LLL 270	SUPERIOR	SUPERIOR	SUPERIOR	SUPERIOR	SUPERIOR	STD	SUPERIOR	SUPERIOR
LLL 280	SUPERIOR	SUPERIOR	SUPERIOR	SUPERIOR	SUPERIOR	STD	SUPERIOR	SUPERIOR
LLL 290	SUPERIOR	SUPERIOR	SUPERIOR	SUPERIOR	STD	STD	SUPERIOR	SUPERIOR
LLL 300	SUPERIOR	SUPERIOR	SUPERIOR	SUPERIOR	STD	STD	SUPERIOR	STD
LLL 310	SUPERIOR	SUPERIOR	SUPERIOR	SUPERIOR	STD	STD	SUPERIOR	STD
LLL 320	SUPERIOR	STD	SUPERIOR	SUPERIOR	STD	STD	STD	STD
LLL 330	SUPERIOR	STD	SUPERIOR	SUPERIOR	STD	STD	STD	STD
LLL 340	SUPERIOR	STD	SUPERIOR	SUPERIOR	STD	STD	STD	STD
LLL 350	STD	STD	SUPERIOR	SUPERIOR	STD	STD	STD	STD
LLL 360	STD	STD	SUPERIOR	STD	STD	STD	STD	STD
LLL 370	STD	STD	STD	STD	STD	STD	STD	STD
LLL 380	STD	STD	STD	STD	STD	STD	STD	STD
LLL 390	STD	STD	STD	STD	STD	STD	STD	STD
LLL 400	STD	STD	STD	STD	STD	STD	STD	STD
LLL 410	STD	STD	STD	STD	STD	STD	STD	STD
LLL 420	STD	STD	STD	STD	STD	STD	STD	STD
LLL 430	STD	STD	STD	STD	STD	STD	STD	STD
LLL 440	STD	STD	STD	STD	STD	STD	STD	STD
LLL 450	STD	STD	STD	STD	STD	STD	STD	STD
LLL 460	STD	STD	STD	STD	STD	STD	STD	STD
LLL 470	STD	STD	STD	STD	STD	STD	STD	STD
LLL 480	STD	STD	STD	STD	STD	STD	STD	STD
LLL 490	STD	STD	STD	STD	STD	STD	STD	STD
LLL 500	STD	STD	STD	STD	STD	STD	STD	STD
LLL 510	STD	Red	STD	Red	STD	Red	STD	Red

TABLA 3

Protectores de composite y carbono / diámetro y posición rueda trasera

Posición	Rueda trasera 22"						Rueda trasera 24"						Rueda trasera 25"						Rueda trasera 26"					
	1	2	3	4	5	6	1	2	3	4	5	6	1	2	3	4	5	6	1	2	3	4	5	6
RSTF360																								
RSTF370																								
RSTF380																								
RSTF390																								
RSTF400																								
RSTF410																								
RSTF420																								
RSTF430																								
RSTF440																								
RSTF450																								
RSTF460																								
RSTF470																								
RSTF480																								
RSTF490																								
RSTF500																								

Protectores antisalpicaduras fijos y desmontables (plástico) / diámetro y posición rueda trasera

Posición	Rueda trasera 22"						Rueda trasera 24"						Rueda trasera 25"						Rueda trasera 26"					
	1	2	3	4	5	6	1	2	3	4	5	6	1	2	3	4	5	6	1	2	3	4	5	6
RSTF360																								
RSTF370																								
RSTF380																								
RSTF390																								
RSTF400																								
RSTF410																								
RSTF420																								
RSTF430																								
RSTF440																								
RSTF450																								
RSTF460																								
RSTF470																								
RSTF480																								
RSTF490																								
RSTF500																								

Protectores antisalpicaduras carbono (fijos y desmontables) / diámetro y posición rueda trasera

Posición	Rueda trasera 22"						Rueda trasera 24"						Rueda trasera 25"						Rueda trasera 26"					
	1	2	3	4	5	6	1	2	3	4	5	6	1	2	3	4	5	6	1	2	3	4	5	6
RSTF360																								
RSTF370																								
RSTF380																								
RSTF390																								
RSTF400																								
RSTF410																								
RSTF420																								
RSTF430																								
RSTF440																								
RSTF450																								
RSTF460																								
RSTF470																								
RSTF480																								
RSTF490																								
RSTF500																								

TABLA 4

Frenos en relación con posición, diámetro rueda trasera y profundidad asiento

	POSICIÓN RUEDA TRASERA	Rueda trasera 22"						Rueda trasera 24"						Rueda trasera 25"						Rueda trasera 26"					
		1	2	3	4	5	6	1	2	3	4	5	6	1	2	3	4	5	6	1	2	3	4	5	6
Frenos empuje	SD 320-380							■	■					■	■					■	■	■			
	SD 400							■						■						■	■				
	SD 420																			■					
	SD 440																								
	SD 460																								
	SD 480																								
	SD 500																								
Frenos tiro	SD 320-380	■						■	■					■	■	■				■	■	■			
	SD 400							■						■	■					■	■				
	SD 420													■						■					
	SD 440																								
	SD 460																								
	SD 480																								
	SD 500																								
Frenos activos	SD 320-380	■	■	■	■			■	■	■	■			■	■	■	■			■	■	■	■		
	SD 400	■	■	■		■		■	■	■	■			■	■	■	■			■	■	■	■		
	SD 420	■	■		■			■	■	■	■			■	■	■	■			■	■	■	■		
	SD 440	■	■					■	■	■				■	■	■	■			■	■	■	■		
	SD 460	■	■					■	■	■				■	■	■	■			■	■	■	■		
	SD 480	■	■					■	■	■				■	■	■	■			■	■	■	■		
	SD 500	■	■					■	■	■				■	■	■	■			■	■	■	■		
Frenos activos ligeros	SD 320-380							■						■	■					■	■	■			
	SD 400													■						■	■				
	SD 420																			■					
	SD 440																								
	SD 460																								
	SD 480																								
	SD 500																								

TABLA 5
Antivuelco en relación con FSTF (altura asiento delantera), RSTF (altura asiento trasera) y diámetro rueda trasera

22"	FSTF 380	FSTF 390	FSTF 400	FSTF 410	FSTF 420	FSTF 430	FSTF 440	FSTF 450	FSTF 460	FSTF 470	FSTF 480	FSTF 490	FSTF 500	FSTF 510	FSTF 520	FSTF 530
22"	RSTF360															
	RSTF370															
	RSTF380															
	RSTF390															
	RSTF400															
	RSTF410															
	RSTF420															
	RSTF430															
	RSTF440															
	RSTF450															
	RSTF460															
	RSTF470															
	22"	RSTF390														
RSTF400																
RSTF410																
RSTF420																
RSTF430																
RSTF440																
RSTF450																
RSTF460																
RSTF470																
RSTF480																
RSTF490																
25"	RSTF410															
	RSTF420															
	RSTF430															
	RSTF440															
	RSTF450															
	RSTF460															
	RSTF470															
	RSTF480															
	RSTF490															
	RSTF500															
	26"	RSTF420														
RSTF430																
RSTF440																
RSTF450																
RSTF460																
RSTF470																
RSTF480																
RSTF490																

TABLA 6

Reposapiés ajustables en ángulo en relación con LLL (largo de pierna) y FSTF (altura asiento delantera)

LLL	FSTF	410	420	430	440	450	460	470	480	490	500	510	520	530
210		Red	Red	Red	Red	Red	Red	Red	Red	Red	Red	Red	Red	Red
220		Red	Red	Red	Red	Red	Red	Red	Red	Red	Red	Red	Red	Red
230		Red	Red	Red	Red	Red	Red	Red	Red	Red	Red	Red	Red	Red
240		Red	Red	Red	Red	Red	Red	Red	Red	Red	Red	Red	Red	Red
250		Red	Red	Red	Red	Red	Red	Red	Red	Red	Red	Red	Red	Red
260		Red	Red	Red	Red	Red	Red	Red	Red	Red	Red	Red	Red	Red
270		Red	Red	Red	Red	Red	Red	Red	Red	Red	Red	Red	Red	Red
280		Red	Red	Red	Red	Red	Red	Red	Red	Red	Red	Red	Red	Red
290		Red	Red	Red	Red	Red	Red	Red	Red	Red	Red	Red	Red	Red
300		Red	Red	Red	Red	Red	Red	Red	Red	Red	Red	Red	Red	Red
310		Red	Red	Red	Red	Red	Red	Red	Red	Red	Red	Red	Red	Red
320		Red	Red	Red	Red	Red	Red	Red	Red	Red	Red	Red	Red	Red
330		Red	Red	Red	Red	Red	Red	Red	Red	Red	Red	Red	Red	Red
340		Red	Red	Red	Red	Red	Red	Red	Red	Red	Red	Red	Red	Red
350		Red	Red	Red	Red	Red	Red	Red	Red	Red	Red	Red	Red	Red
360		Red	Red	Red	Red	Red	Red	Red	Red	Red	Red	Red	Red	Red
370		Red	Red	Red	Red	Red	Red	Red	Red	Red	Red	Red	Red	Red
380		Red	Green	Green	Green	Green	Green	Green	Green	Green	Green	Green	Green	Green
390		Red	Red	Green	Green	Green	Green	Green	Green	Green	Green	Green	Green	Green
400		Red	Red	Red	Green	Green	Green	Green	Green	Green	Green	Green	Green	Green
410		Red	Green	Green	Green	Green	Green	Green	Green	Green	Green	Green	Green	Green
420		Red	Green	Green	Green	Green	Green	Green	Green	Green	Green	Green	Green	Green
430		Red	Green	Green	Green	Green	Green	Green	Green	Green	Green	Green	Green	Green
440		Red	Green	Green	Green	Green	Green	Green	Green	Green	Green	Green	Green	Green
450		Red	Red	Green	Green	Green	Green	Green	Green	Green	Green	Green	Green	Green
460		Red	Red	Red	Green	Green	Green	Green	Green	Green	Green	Green	Green	Green
470		Red	Red	Red	Red	Green	Green	Green	Green	Green	Green	Green	Green	Green
480		Red	Red	Red	Red	Red	Green	Green	Green	Green	Green	Green	Green	Green
490		Red	Red	Red	Red	Red	Red	Green	Green	Green	Green	Green	Green	Green
500		Red	Red	Red	Red	Red	Red	Red	Green	Green	Green	Green	Green	Green
510		Red	Red	Red	Red	Red	Red	Red	Red	Green	Green	Green	Green	Green
520		Red	Red	Red	Red	Red	Red	Red	Red	Red	Green	Green	Green	Green
530		Red	Red	Red	Red	Red	Red	Red	Red	Red	Red	Green	Green	Green